

### Microsoft Teams Rooms System for Small Meeting Room

Yealink MVC 400 is a native and easy-to-use video conferencing solution specially designed for Microsoft Teams rooms. MVC 400 features the native Microsoft Teams-tailored user interface that is easy to be operated with close-to-zero learning curve, and you just walk into the meeting room and start your scheduled Teams or Skype for Business meeting with one-touch join. Together with 8 MEMS microphone arrays and 133 ° field of view, its AI technologies, including face detection, sound localization, and speaker tracking and so on, provide users with high-quality call experience in full-duplex mode. Only including a high-permance MCore, a touch panel MTouch II, and a USB video bar UVC40, MVC400 is the optimum choice for small meeting rooms with easy deployment.



Easy  
Deployment



20 MP  
Camera



Auto Framing



Speaker  
Tracking



Electric Lens  
Cap



8x e-PTZ  
Camera



Device  
Management



#### Key Features and Benefits

##### Native Microsoft Teams-Tailored User Interface, Smooth Conference Experience

Native Microsoft Teams-tailored user interface offers a one-touch meeting join. Designed with the idea of multi-function all-in-one, the MTouch II touch panel allows you easily perform call control, camera control, content sharing and other functions. At the same time, MTouch II has a built-in Human Motion Sensor that the conference system can be automatically waken up and you can immediately start the conference.

##### Smart Video Conferencing with AI Technology

Featuring AI technology, including Auto Framing and Speaker Tracking, UVC40 not only supports framing the groups automatically according to the number and the position of the participants, but also automatically zoom in the speaker without adjusting the camera, making the participants more focus on the conference.

##### Precise Sound Localization, Full-Duplex Experience

8 MEMS microphone arrays make UVC40 have stronger ability of noise proof and dereverberation. The new upgraded beamforming algorithm, together with technology of processing on acoustic echo cancellation and the dereverberation, brings high quality full-duplex call and realizes more precise voice pickup.

##### Secure Conference with Electric Lens Cap

The camera electric lens cap automatically opens when the video conference starts and remains closed when not having video conferences, securing your conference privacy.

##### Content Sharing in Real Time

The unique wireless content sharing solution provides participants with maximum flexibility, that a one-click content sharing can be simply realized by plugging into the WPP20 only. With a high resolution of 1080P / 30 frames, it provides users with a better content sharing experience. Besides, the wired content sharing is also available by connecting to the USB-C port or HDMI port.

##### Simple to Deploy, Easy to Use

With the VCH port, MCore is specially designed for the video meeting rooms that the deployment can be easily extended. At the same time, its all-in-one design with the feature of cable management ensure the stability of the wire connection, and the most appropriate deployment can be achieved according to the layout of the meeting room. One CAT5e is totally enough to connect the TV area and the conference table area and to complete the data transmission and power supply, no additional power supply or extension cable is needed, which not only simplifying the deployment but also effectively reducing deployment costs.

##### Remote Device Management

This solution supports Yealink Device Management Platform/Cloud Service, you can flawlessly manage, monitor, configure, update and diagnose all Yealink audio and video devices peripherals on this platform remotely.

### Package Content

- MCore Mini-PC
- MTouch II touch panel
- UVC40 USB video bar

### Preload

- Windows 10 IoT Enterprise X64
- Windows 10 IoT Enterprise License
- Microsoft Teams Rooms App, support Skype for Business on-premise/online and Teams meetings
- Yealink RoomConnect

### MCore Mini-PC

- 8<sup>th</sup>-gen Intel® QUAD-CORE i5
- Memory: 8GB (2 x 4GB)
- Storage: 128GB SSD
- 2 x HDMI video output with CEC supported
- Bluetooth and Wi-Fi
- 1x Yealink VCH port (RJ45), connect to MTouch II
- 4 x USB3.0 Type-A
- 1 x 10/100/1000M Ethernet port
- 1 x Power port
- 1 x Security lock slot
- Integrated cable management

### MTouch II Touch Panel

- 8-inch IPS screen
- 1280 x 800 resolution
- 10-point capacitive touch screen
- 3.5mm headset jack
- Human Motion Sensor
- Angle adjustable bracket (28° ~ 50°)
- 1080P/30FPS FHD for sharing
- Support wired and wireless content sharing
- Built-in Wi-Fi AP for Yealink wireless presentation device
- HDMI/USB-C video input

### UVC40 USB Video Bar

- 20 MP Camera
- 8x e-PTZ camera
- Field of view (diagonal): 133°
- Auto Framing
- Speaker Tracking
- AI Face Enhancement
- Camera presets
- Built-in 8 MEMS microphone array
- Yealink Noise Proof Technology
- Beamforming directed voice pickup technology
- Full-duplex technology
- Echo cancellation technology

- 1 x Line-in (3.5mm)
- 1 x Yealink Microphone port (RJ-45)
- 1 x USB 3.0 Type-B
- 1 x USB 2.0 Type-A
- 1 x Power port
- 1 x Security lock slot
- 1 x Reset slot
- 1 x 2.5m USB 2.0 cable

### Package Features

- N.W/CTN: 6.4 Kg
- G.W/CTN: 7.6 Kg
- Carton Meas: 685mm x 356mm x 285mm

### Product Dimension (W.D.H)

- MTouch II: 202mm x 151mm x 100mm  
N.W/CTN: 1kg
- MCore: 168mm x 197mm x 39mm  
N.W/CTN: 1.35kg
- UVC40: 600mm x 68mm x 82mm  
N.W/CTN: 2.56kg

## Scene Graph in a Conference Room

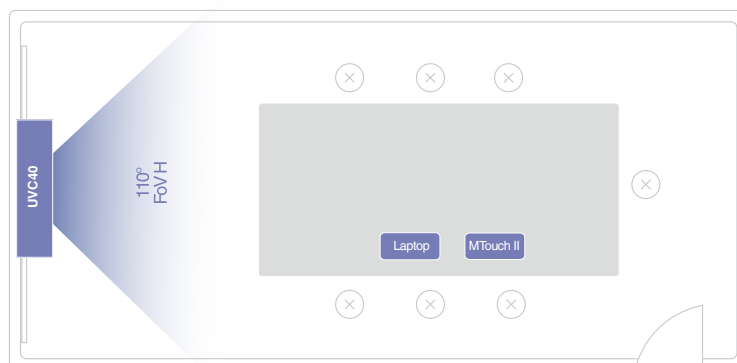
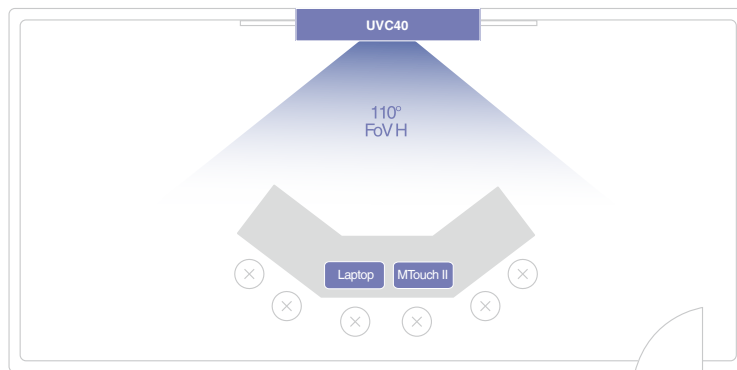

## Connection

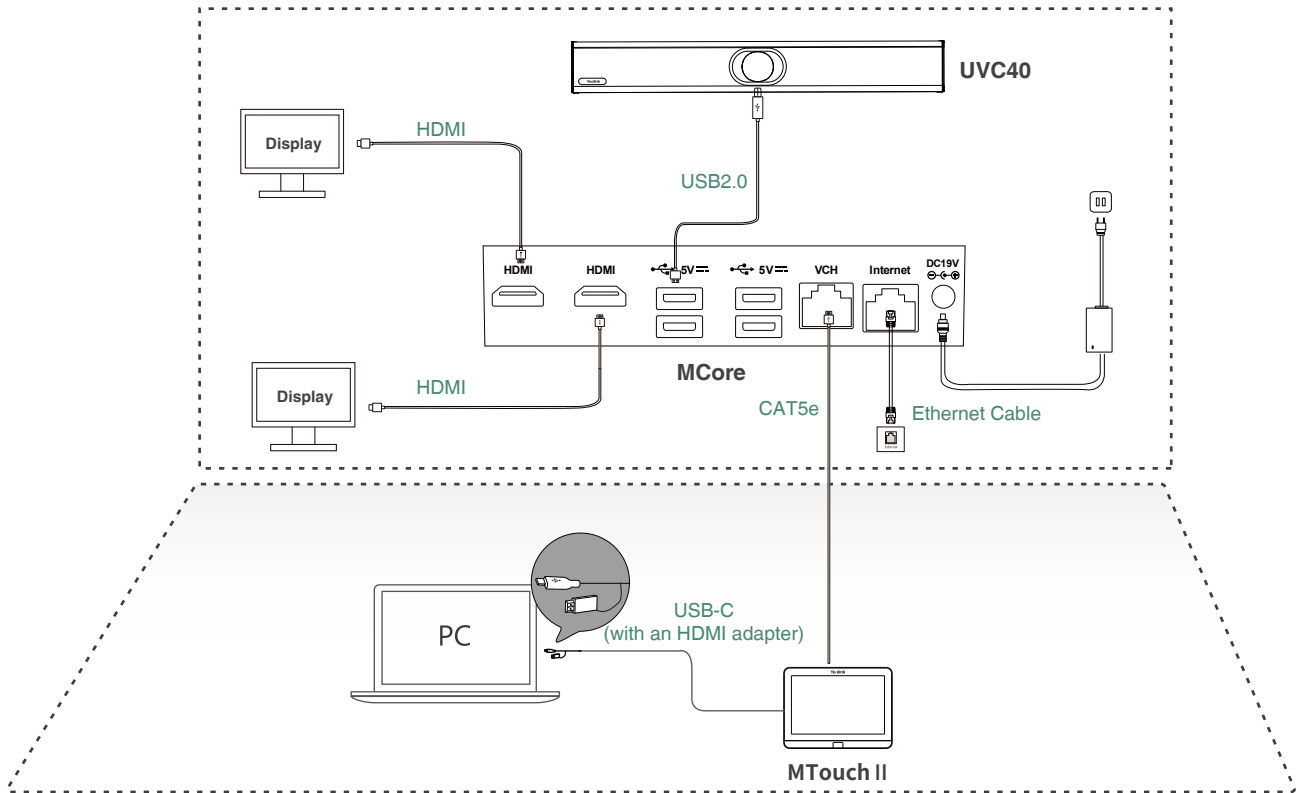

- 💡 When starting up the system for the first time, you need to connect a mouse to complete the initial configuration. We recommend using the wireless mouse and keyboard kit.
- 💡 For more information about the installation and deployment of accessories (for example, the installation of the MCore package or the UVC40 camera), refer to the Quick Start Guide of corresponding accessory.

## About Yealink

Yealink is a global leading provider of enterprise communication and collaboration solutions, offering video conferencing service to worldwide enterprises. Focusing on research and development, Yealink also insists on innovation and creation. With the outstanding technical patents of cloud computing, audio, video and image processing technology, Yealink has built up a panoramic collaboration solution of audio and video conferencing by merging its cloud services with a series of endpoints products. As one of the best providers in more than 140 countries and regions including the US, the UK and Australia, Yealink ranks No.1 in the global market share of SIP phone shipments.

## Copyright

Copyright © 2020 YEALINK(XIAMEN) NETWORK TECHNOLOGY CO., LTD.

Copyright © 2020 Yealink(Xiamen) Network Technology CO., LTD. All rights reserved. No parts of this publication may be reproduced or transmitted in any form or by any means, electronic or mechanical, photocopying, recording, or otherwise, for any purpose, without the express written permission of Yealink(Xiamen) Network Technology CO., LTD.

## Technical Support

Visit Yealink WIKI (<http://support.yealink.com/>) for firmware downloads, product documents, FAQ, and more. For better service, we sincerely recommend you to use Yealink Ticketing system (<https://ticket.yealink.com>) to submit all your technical issues.



YEALINK(XIAMEN) NETWORK TECHNOLOGY CO.,LTD.  
Web: [www.yealink.com](http://www.yealink.com)  
Addr: No.1 Ling-Xia North Road, High Tech Park,  
Huli District, Xiamen, Fujian, P.R. China  
Copyright©2020 Yealink Inc. All right reserved.